

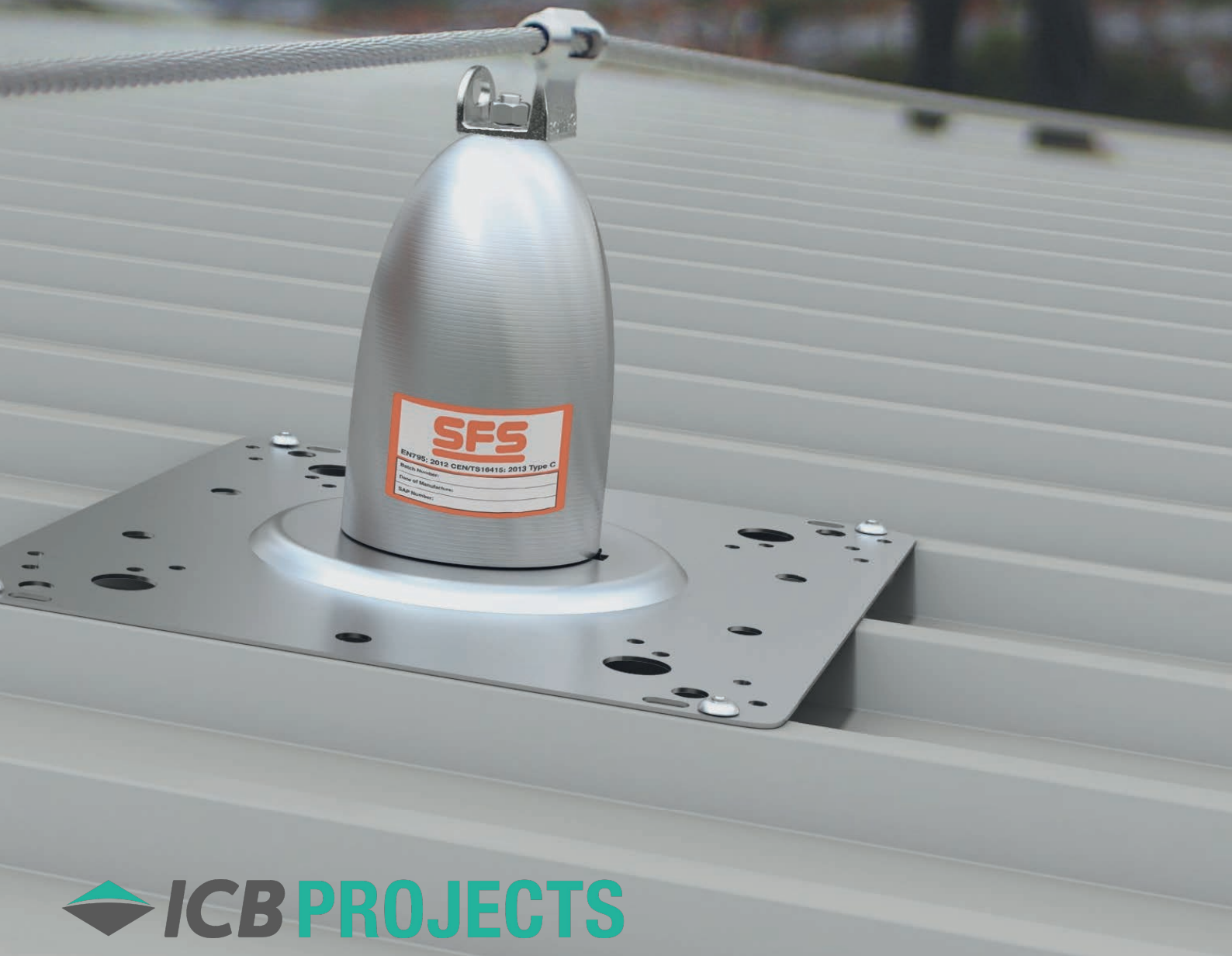

Fall Protection Systems



Contents

| | | | |
|-------------------------------------|---|--|----|
| Introduction | 2 | Tested on all Roof Applications | 10 |
| Product Development | 3 | Line Calculations and System Warranty | 11 |
| Hierarchy of Fall Protection | 4 | Innovative Design | 12 |
| Corrugated Metal Roofing | 5 | Beating Corrosion | 13 |
| Built-up Flat Roofing | 6 | Bespoke Solutions | 14 |
| Metal Standing Seam Roofs | 7 | Site Support and Training | 15 |
| Vertical System | 8 | | |
| Overhead System | 9 | | |

SFS has been evolving its Fall Protection System since its launch, over 10 years ago.

The extensive knowledge gained in the development of fastener solutions for roofing has helped us develop our systems for working at height.

SFS offers systems for industrial pitched metal roofs, built-up flat roofs, vertical and overhead applications.

SFS provides a range of leading Fall Protection Systems that are designed to appeal to all parties who come into contact with working at height applications:

- Safety Installer Companies
- Roofing Contractors
- Architects
- Designers
- Building Owners
- Building Contractors

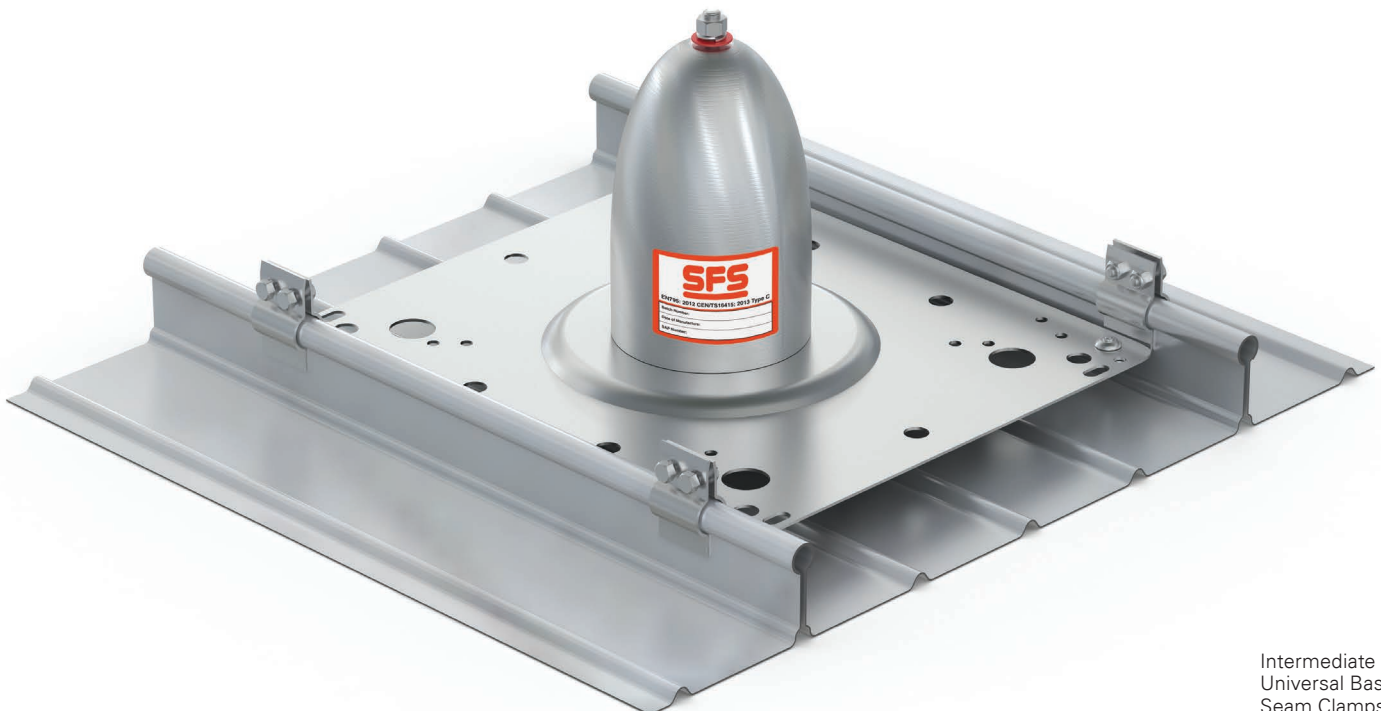

Intermediate Post
Universal Base Plate
Seam Clamps

Product Development

2019

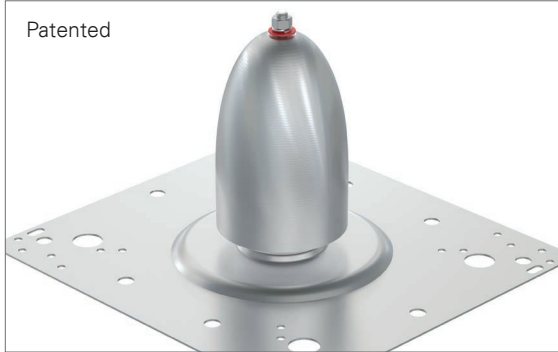

Soter™ II

Optimum shock absorbing element and baseplate, reduces deployment loads to the roof structure to below 6kN. The post is modular, allowing for post removal after deployment without disturbing the roof make-up.

2000s



Shock Absorbing

The requirement to protect the roof as well as the user led to the development of roof anchors incorporating a shock absorbing element. These internal features help to minimise the load the rivets / fasteners would be subjected to in the event of a fall. Reduced number of fixing points, speeding up installation times.

1990s



Semi-Rigid Top Fix Post

In line with the increase in metal and sandwich panel roof constructions came the development of the externally fixed post, secured with rivets or drill screws. These posts feature a minimal shock absorbing element which would still result in roof damage when a fall occurred.

1980s



Rigid Through Fix Post

Early rigid posts were secured through to the building frame and meant access was required internally and externally at the same time, making it very labour intensive and costly to install. The post penetrates the whole roof, adding the need for weather proofing around each post location. The weathering inevitably broke down after time, leading to leaks and further roof work being needed.

These early posts had no shock absorbing element to them and the potential for serious damage to the roof is high when a fall occurs.

Hierarchy of Fall Protection

A designer or building owner must ensure the safety of a worker, if the need to work at height cannot be avoided.

Defined by the Hierarchy Triangle, where there is any risk of a fall, the system must be designed and classed as an arrest system.

A system can only be deemed restraint where there is no possibility of a fall.

“Avoid work at height wherever possible!”

This is a well known Health and Safety protocol, where working at height is required, we are all responsible for minimising the risks. When roof access cannot be avoided, all current guidance calls for “work restraint” systems as the safest option. SFS design to restraint by default.

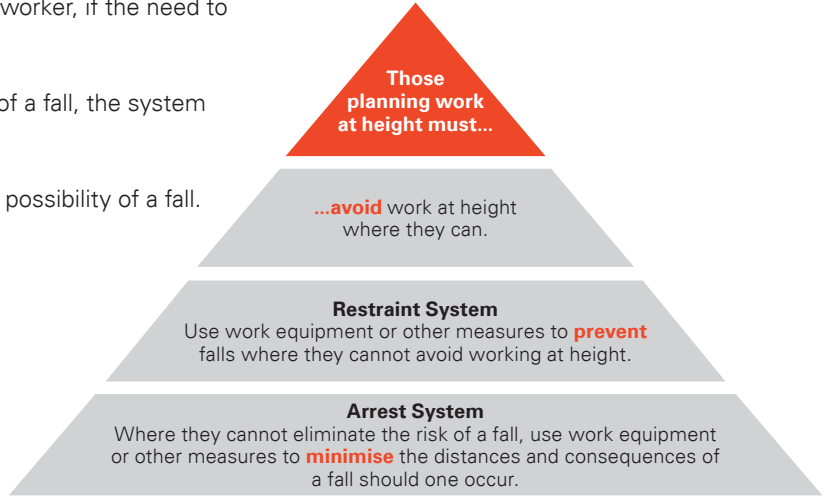

Restraint

No risk of a fall

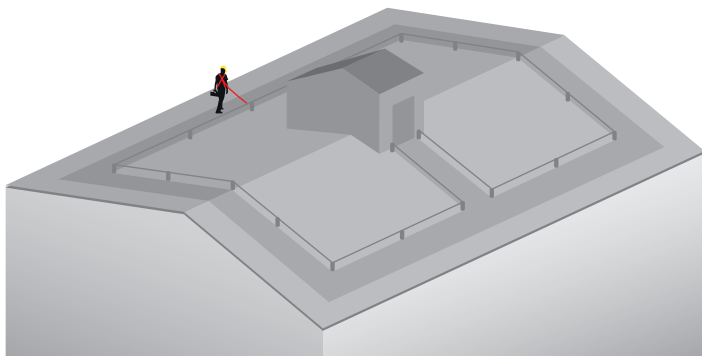

A typical restraint system is set 2.3m back from the roof perimeter or any open edge or potential fall. The user’s path is dictated.

Minimal PPE and user training required.

Arrest

Potential for a fall

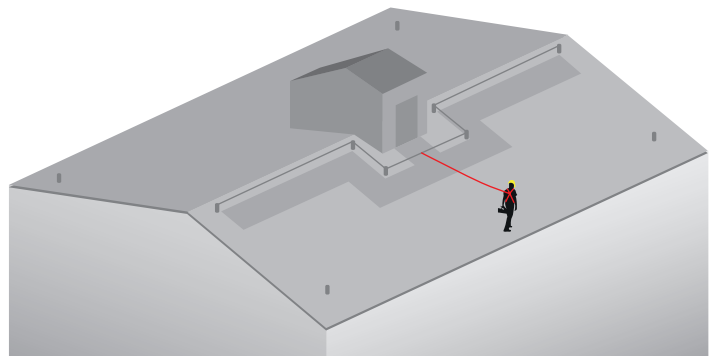

A fall arrest system requires more input from a design point of view, this should always be backed up with published calculations applicable to the roof substrate type. Other factors such as building height and fall clearances require due consideration.

This type of system requires specialist PPE, user training **and** a rescue plan to be in place.

Corrugated Metal Roofing

SFS Fall Protection System for sandwich panels with top skins from 0.5 mm.

The use of structural BULB-TITE® rivets from SFS group company Gesipa, enables the base plates to be fixed to the crowns of the panels quickly and securely.

The rivet performs a sealing, clamping and security function.

SFS Fall Protection Systems installed on sandwich panels can be utilised for arrest or restraint - subject to correct layout and design.

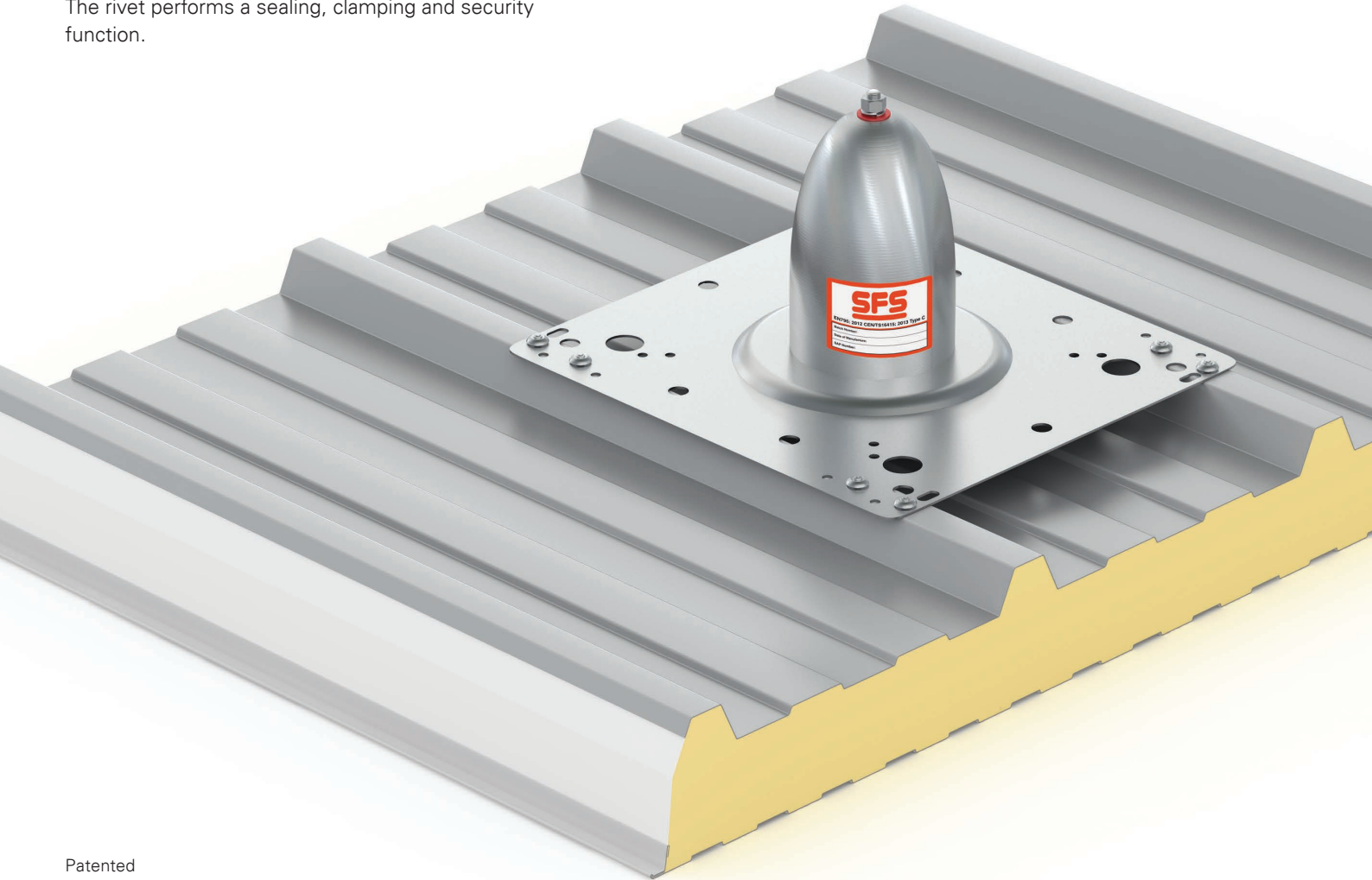

Patented

Structural BULB-TITE® Rivets



Typical Values

| Fastener | Substrate | Shear | Tension (pull-out) |
|--------------------------------|-----------|---------|--|
| 5.5 dia | 2 x 0.7 | 0.9 kn | 0.5 kn |
| 6.3 dia | 2 x 0.7 | 1.7 kn | 1.4 kn |
| 7.9 dia BULB-TITE® Rivet | 2 x 0.7 | 2.05 kn | 2.9 kn up to 6 x stronger |

Built-up Flat Roofing

Solutions are available for all types of flat roof build-ups.

M8 Stainless steel gravity toggles, from 150–500 mm are one option on profile metal deck over 0.6 mm and timber and OSB decks over 18 mm. The SFS toggle cup design recesses the bolt head below the flat surface of the base plate. This eliminates the risk of puncture damage to the membrane.

Options for concrete decks include M8 stainless rods & resin.

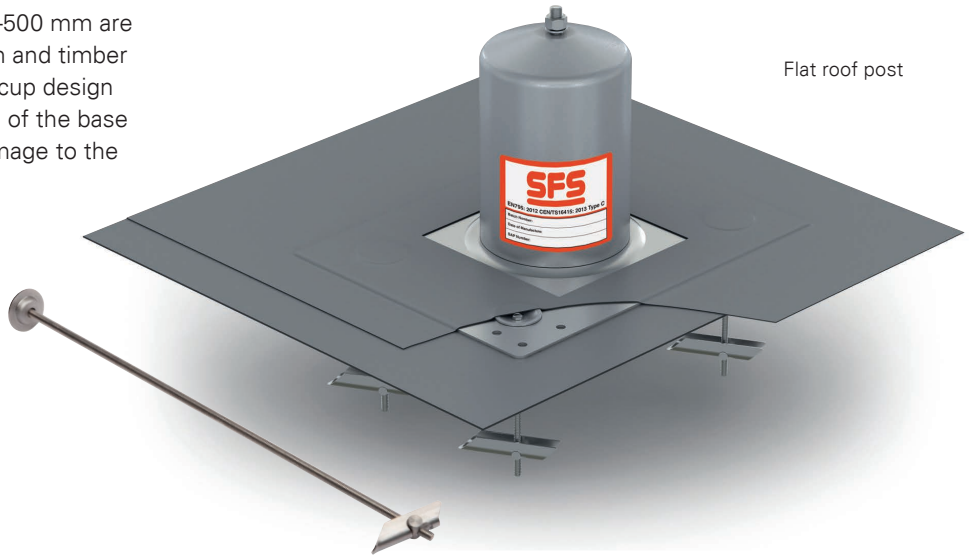

Flat roof post insulation

Concrete deck (also available as concrete screw)



Flat roof post insulation

OSB board / 18 mm ply (also available as sleeve and fastener)

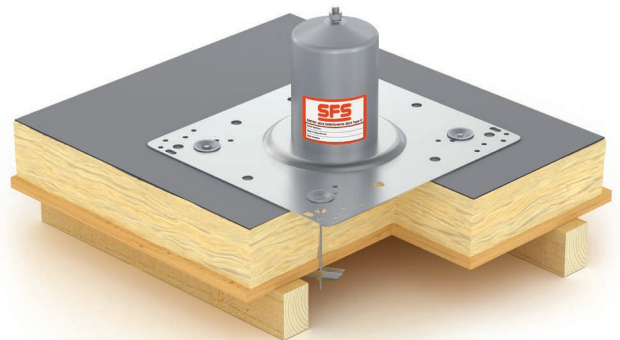

Flat roof post insulation

Metal deck (also available as sleeve and fastener)

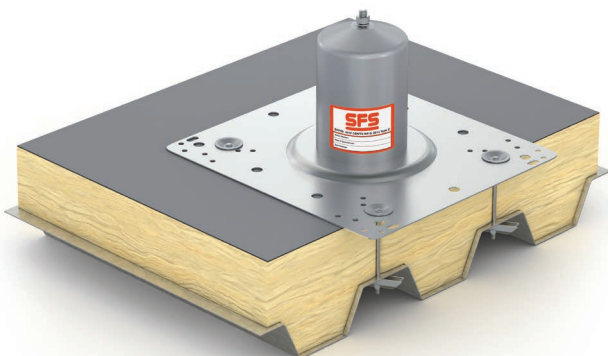

Flat roof post insulation

Concrete deck (sleeve and fastener)

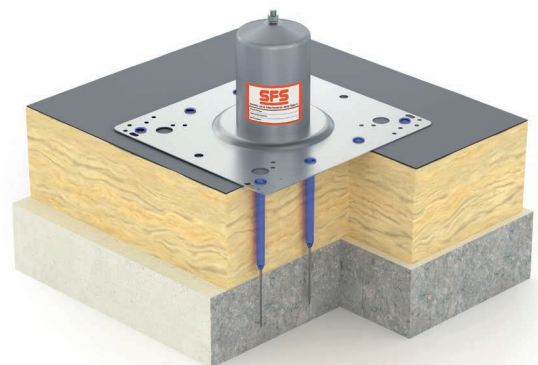

Metal Standing Seam Roofs

Standing seam roofing systems, designed to avoid outer skin penetrations, prevent the use of rivets in securing anchor posts.

SFS support leading manufacturers of standing seam roofs by only recommending horizontal line systems that are designed to restraint.

SFS have a range of clamps to suit most profiles.

Standing seam roofs do not have the same strength as many mechanically fixed sheets and panels, this means that they might be unable to sustain the higher loads generated by a fall on an arrest system.

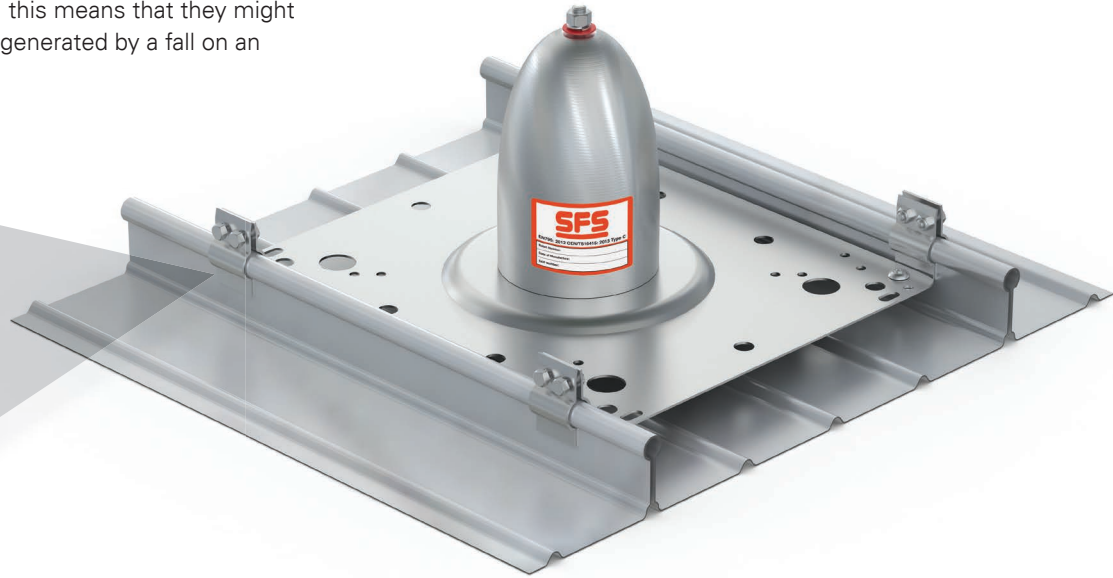

Riveted Soter™ Seam Clamp
Aluminium Rolled Seams
Non-penetrative

Bolted Seam Clamp

Aluminium Rolled Seams - unique

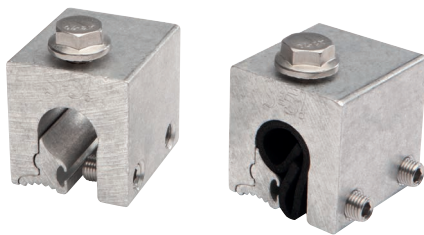

River-Therm® Clamp

Non-penetrative solution

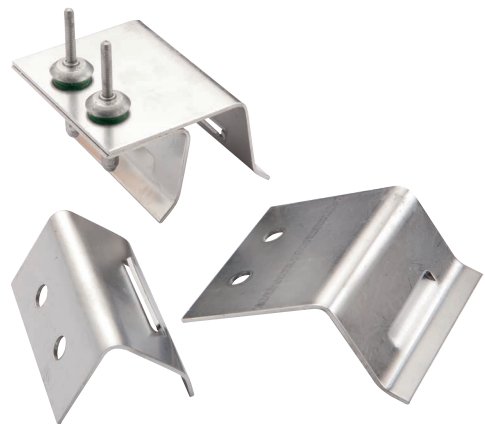

Folded Seam Clamp

Traditional standing seam roofs such as copper and zinc



Vertical System

SFS Fall Protection System for vertical applications

Meets the latest requirements of BS EN 353-1:2014

The innovative design of the helix intermediate brackets allows for easier and safer installation of the system. The brackets can be installed once the wire is under tension.

Vertical line attachment device

Incorporates its own shock absorber.



Toggle Fork

Extended for ease of egress

Upper Bracket

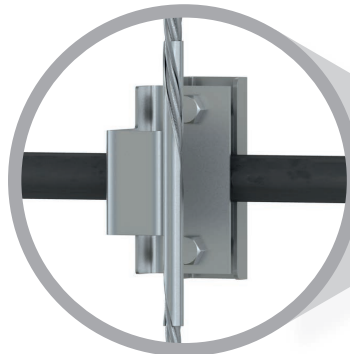

Helix Intermediate Bracket

Lower Bracket

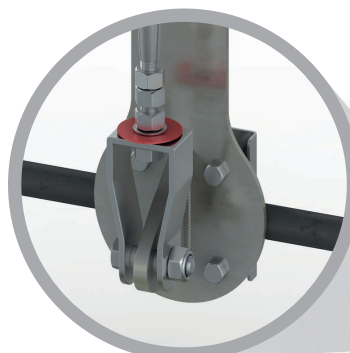

Combined Tension Indicator

Overhead System

SFS Fall Protection System for overhead applications

Our overhead lifeline system is designed to provide continuous fall protection for users in exposed work place situations.

For example:

- Modular building construction
- Trailer maintenance
- Internal overhead crane inspections
- Train maintenance

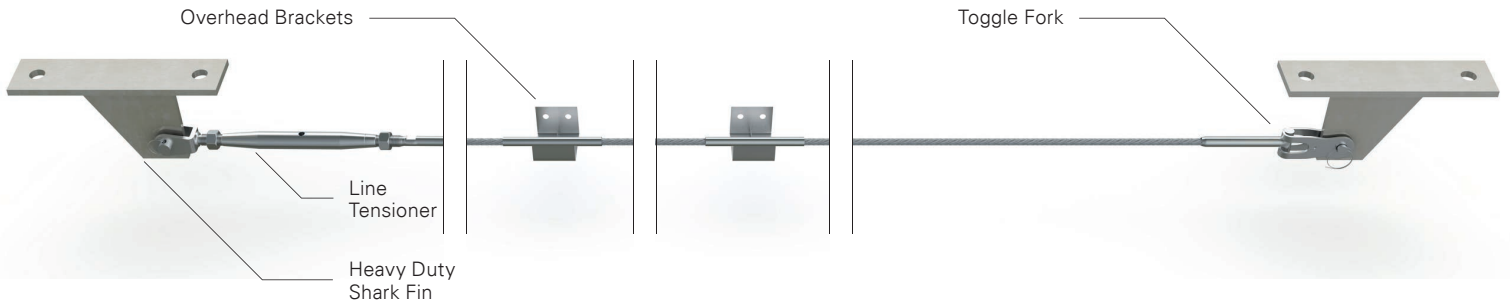

Soter™ overhead personal attachment trolley

with removable feature



Single span lengths

up to 30m spans are achievable with 1x19x7 mm wire pre-tensioned to 5kN.

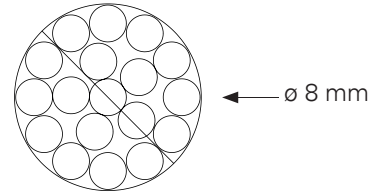

Line Calculations Program

It is important that a calculations program is used to calculate reflections, free fall heights and clearances. Calculations are available from SFS via the office, or online.

| SFS Overhead System Configurator | | System Details <small>(Enter your results below from the solutions given on the right. A typical example is given in grey)</small> | | | |
|--|----------------|--|--------------------|--------------------|--------------------------|
| Input data | | Length (m) | Max Fa (kN) | Max Fm (kN) | Deflection D (mm) |
| Maximum span between anchors (So) | 10 m | System total length | 50 | N/A | N/A |
| Total system length (Ls) | 40 m | Systems shortest span | 10 | 5.12 | 5.17 |
| Initial tension in cable (To) | 800 N | Systems longest span | 20 | 5.39 | 4.00 |
| Mass of falling person (m) | 200 kg | Other spans of interest | 6 | 5.30 | 4.74 |
| Wire construction CSA | B | | | | |
| Solution | | | | | |
| Elongation of loaded half span (Eh) | 5.000197205 m | | | | |
| Maximum tension at impact point (T) | 12.18 kN | | | | |
| Maximum deflection at impact point (D) | 1.459 m | | | | |
| Maximum end load safety factor (Em) | System is okay | | | | |

Tested on all Roof Applications

Provides predictable product performance

SFS have their own state-of-the-art testing facilities, a 6x6 m test bed and 12 m drop tower, suitable for testing to all current EU regulations and standards.

SFS Fall Protection Systems have been independently assessed and comply to EN795:2012 as well as the recently published

EN 795:2012 (UNI11578) – Passed & certified

1. Deals specifically with single-user anchor devices.
2. BS EN 795:2012 states, "Requirements and test methods for multi-user anchor devices, i.e. anchor devices that allow more than one user to be attached at any time, are provided in a separate Technical Specification CEN/TS16415:2013.
3. BS EN 795:2012 also states that in recognition of foreseeable misuse, anchor devices intended for restraint must be capable to arrest a fall.

AS/NZS 1891.2:2001 – Passed & certified

Industrial fall-arrest systems and devices
A joint Australian/New Zealand Standard covering Industrial fall arrest systems and devices. Specifically horizontal lifeline and rail systems and prescribed configurations for horizontal lifelines.

1. References many of the requirements for anchor devices as to comply with EN795:2012.
2. A tensile force equal to 90% +/- 5% of the stated initial operating force for 2 minutes +/- 20 seconds without any sign of initial operation.
3. Initial operation of the device shall occur at a tensile force laying within +/-10% of the stated force.

CEN/TS16415:2013 multi-user technical specification and AS/NZS1891.2:2001. SFS UK also test to ACR[M]002:2009-(Part2) Testing of Roof Anchors on Roof Systems known as the "Magenta" test method.

CEN/TS16415:2013 (UNI11578) – Passed & certified

In recognition that horizontal lifelines frequently need to accommodate multiple users a technical specification (CEN/TS16415:2013) has been written to support the new EN 795:2012 standard.

The technical specification states:

1. Anchor devices must be compliant with EN 795:2012.
2. Multi-user devices must now be tested to simulate a minimum of two users falling simultaneously.
3. In addition the Soter™ II system is tested to accommodate four users.

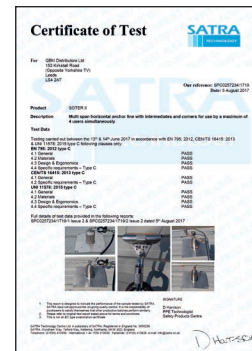

Test bed and drop tower



Testing Aluminium Standing Seam



Testing Composite panel

Line Calculations and Safety Warranty

Calculation Package and Loadings

SFS Fall Protection systems come complete with a calculation package which allows for calculations to be made to give end loadings, system deflections and other detailed information assisting the system designer to propose a system that is fit

for purpose. This calculation package can be used on shock absorbing posts, and components with in-line shock absorbers for systems fitted to rigid/fabricated posts, walls, and rigid structures.

Line Calculations Program

SFS Line System Configurator

Input data

| | | |
|--|-----|----|
| Maximum span between anchors (S_a) | 10 | m |
| Total system length (L_s) | 50 | m |
| Initial tension in cable (T_0) | 800 | N |
| Mass of falling person (m) | 100 | kg |
| Wire construction CSA | B | |

Solution

| | | |
|--|----------|----|
| Elongation of unloaded half span (E_h) | 5.024651 | m |
| Maximum tension at anchor (F_a) | 5.39 | kN |
| Maximum deflection at impact point (D) | 2.0769 | m |

Notes

| | |
|-----------------------------------|---|
| 8mm 1x19 wire rope construction = | A |
| 8mm 7x7 wire rope construction = | B |
| 8mm 7x19 wire rope construction = | C |

System Details

(Enter your results below from the solutions given on the right. A typical example is given in grey)

| Solution data | Length (m) | Max F_a (kN) | Max F_m (kN) | Deflection D (mm) |
|-------------------------|------------|----------------|----------------|---------------------|
| System total length | 100 | N/A | N/A | N/A |
| Systems shortest span | 2 | 5.12 | 5.17 | 1.39 |
| Systems longest span | 10 | 5.39 | 4.00 | 2.71 |
| Other spans of interest | 8 | 5.30 | 4.74 | 2.67 |

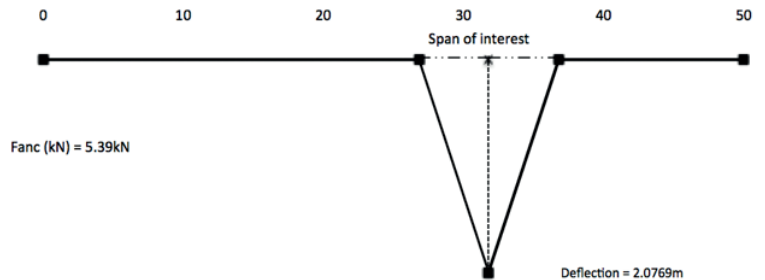

Extended Warranty*

- All products sold within the SFS group carry a standard 12 month "fit for purpose" product warranty*.
- In cases where customers seek additional comfort, they can apply for an extended warranty*.
- Warranty* terms may be 1+24 years... or even longer than this, subject to conditions and project specification.
- A pre-contract questionnaire, covering building use and proximity to chemicals or coastal environment, will be required.
- All warranties are subject to the frequency of inspections and system re-certification.
- The Soter™ SFS warranty* covers all systems installed on Trapezoidal Roof Profiles, Standing Seam and Flat Roofs.
- The Soter™ range is made from non-ferrous & stainless steel components, it carries a design life which goes beyond that of the actual building.
- Standard terms & conditions and covered by our insurance and available on request.

*Standard terms & conditions are available on request

Innovative Design

Patented Energy Absorber

Soter™ has been fully tested and certified to comply with EN795:2012 & CEN/TS:16415:2013 (UNI11578), the requirements of which cover single and multi-users.

In the event of a fall, Soter™ will deploy a uniquely patented energy-absorbing coil that limits the forces developed during free-fall to no greater than 6kN on the roof structure and no greater than 5.5kN on the user attachment point.

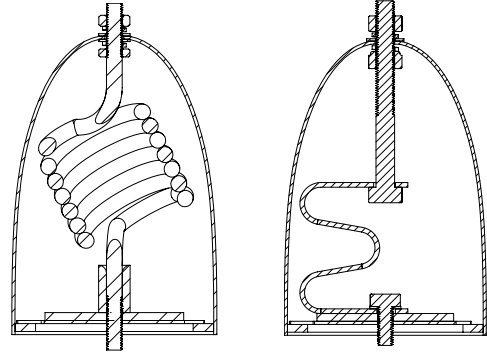

Typical flat roof application

SFS Horizontal Lifeline Systems have been developed to allow users uninterrupted or controlled access to many different roofing applications.

Alternatively they can be installed as a single point anchor for centralised maintenance tasks within a specific area of interest.

As major roofing manufacturers develop profiles of lighter weight and insulation of greater thickness, Soter™ has been designed to complement these advances without compromising structural integrity or user safety.

Designed to be used in fall arrest or work restraint applications.

During product development, major manufacturers played a part in supplying roof profile, insulation and shared their thoughts on how they would like the anchors to perform, to gain their approval. SFS have developed Soter™, a uniquely patented energy-absorbing anchor that, once deployed, reduces the forces generated during free-falling.

The fully stainless solution is housed in a pre-loaded enclosure that is designed to withstand the stresses exerted by snow and ice build-up.

Tested in conjunction with all the major roofing manufacturers of trapezoidal, composite, standing-seam and bituminous & single ply roof systems, there is a solution to all your horizontal safety line needs.



Beating Corrosion

Corrosion of safety line components can also cause unsightly rust stains to appear on the roof sheets. In extreme cases it can cause loss of the integrity of the system as a whole.

It is a common belief that the various protective surface coatings available offer sufficient resistance to corrosion, but this is not the case.

More worrying are the effects of hidden corrosion, often this will only become apparent when needed the most, in a fall situation.

Protective coatings applied to carbon steel elements will only offer temporary corrosion protection.

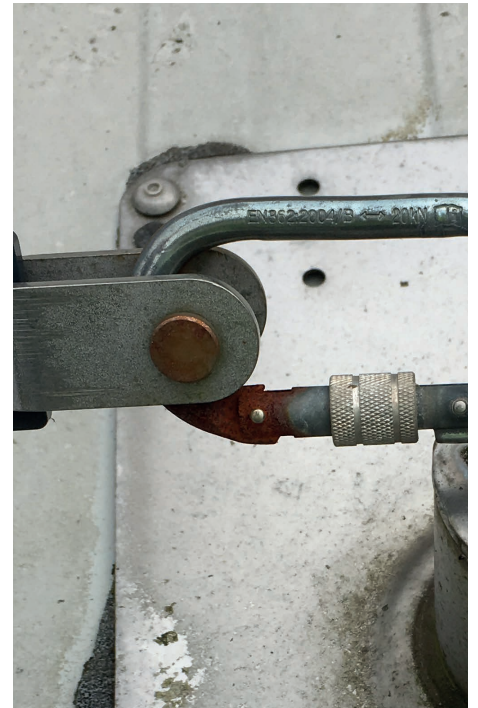

SFS Fall Protection Systems produced with Stainless Steel

SFS understand the problems associated with metals when exposed to the elements. Safety lines are exposed to the weather 365 days a year, for life.

Corrosion is measured in terms of loss of performance which would be catastrophic in a safety line.

Safety lines cannot afford to lose performance.

EN 795:2012 requires **all** components to be subjected to a neutral salt spray test in accordance with EN ISO 9227 for a period in excess of 48 hrs.

After testing, metal parts cannot show any evidence of corrosion.

All components within the SFS Soter™ system **including** internal absorbing elements of the post use a combination of both **304 and 316 stainless steel** giving peace of mind to the end user or building owner that any installed Soter™ system will have a lifespan equal to or beyond the building life.



Bespoke Solutions

With over a decade of experience, SFS has solved many unusual applications including:

- Green Roofs
- Historic buildings
- Slate and tile roofs
- Watercourse access
- Fabricated posts
- Bridges
- PV



Solar Panels



Wall System, St Paul's Cathedral, London

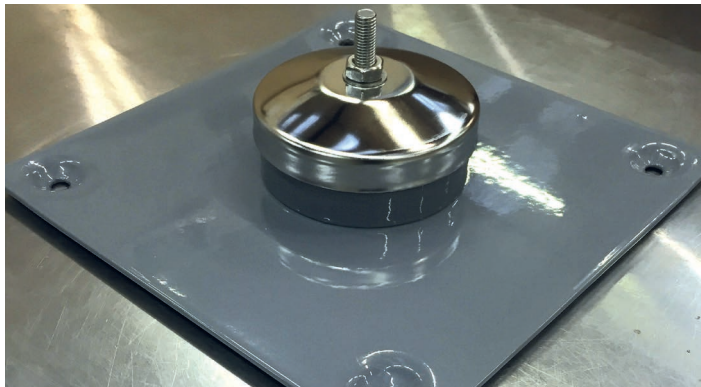

NEW Solar PV Support Post



Forth Road Bridge



Tile Roof System

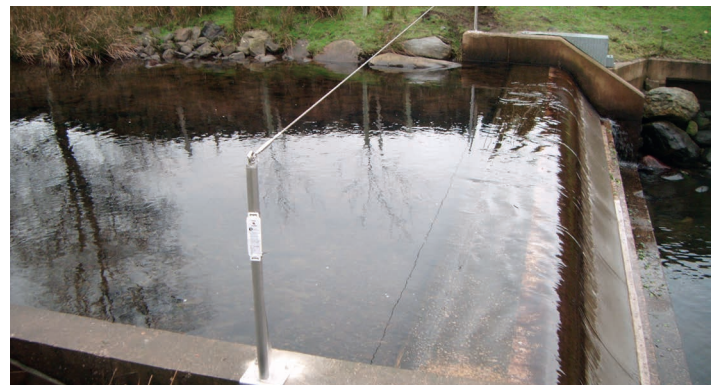

Weir Posts

Site Support and Training

SFS provide comprehensive technical support:

Surveys Site visits to fully understand the requirement of the system and to recommend the most appropriate product and fixing method

Design Full working knowledge of systems, ranging from full access to guided work positioning lines

Quoting In-house estimating and design functions

Training On-site installation and re-certification techniques

Group seminar



On-site training and installation support



Design and quoting consultancy





www.icbprojects.co.uk

ICB (Projects) Ltd. Unit 9 -11, Fleets
Industrial Estate,
Willis Way, Poole, Dorset, BH15 3SU UK
Tel: 01202 785200 Fax: 01202 785201
Email: info@icbprojects.co.uk

SFS Group Fastening Technology Ltd.
Division Construction
153 Kirkstall Road
Leeds, LS4 2AT
fallprotection@sfs.biz
www.sfsintec.co.uk